

ALL DIMENSIONS ARE APPROXIMATE

TOTAL HEIGHT OF PANEL + PIPECOVER
 = 1006 + 2 + 455 + 50 - (OVERLAP)

- OVERLAP IS VARIABLE BETWEEN 20-40MM
- 455 LENGTH CAN BE CUT TO SUIT

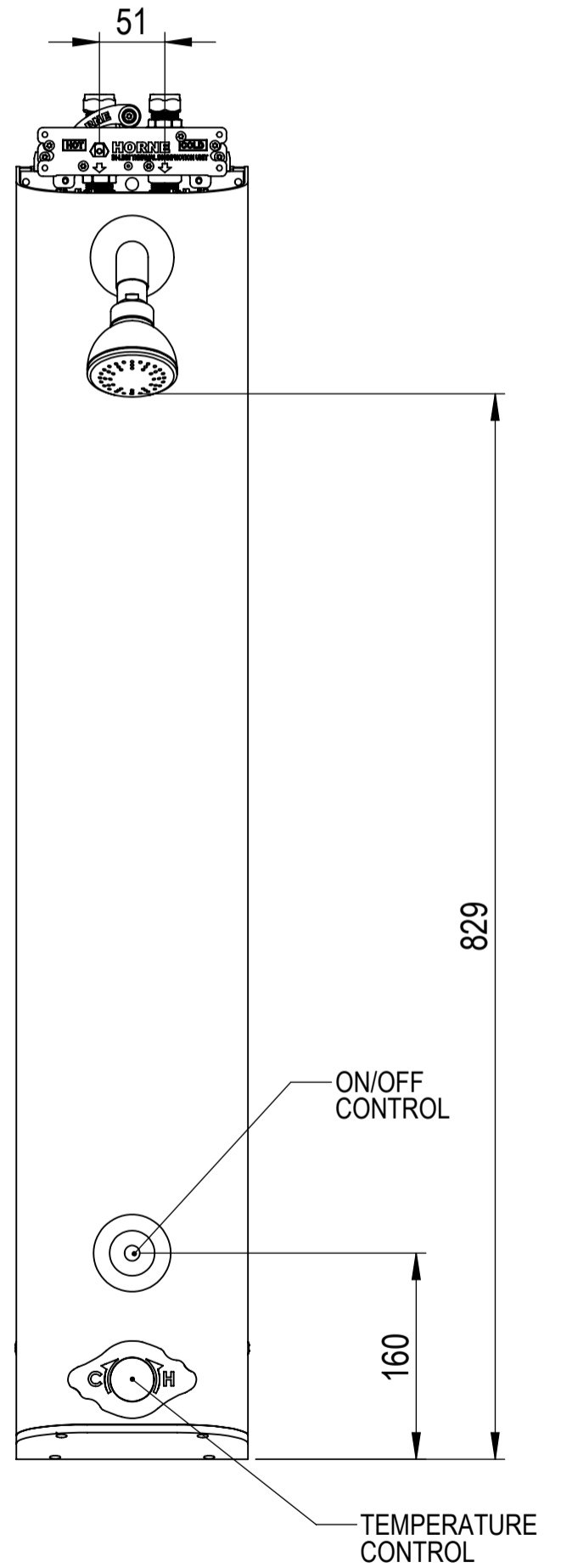
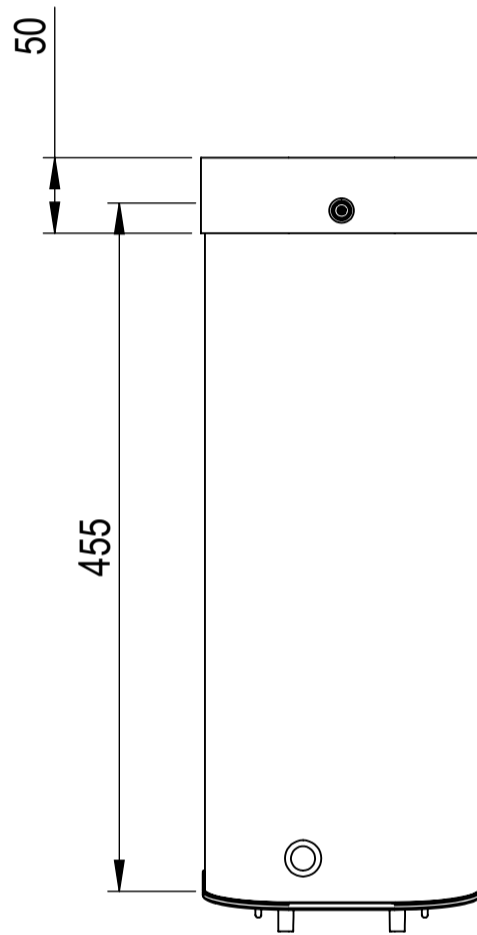
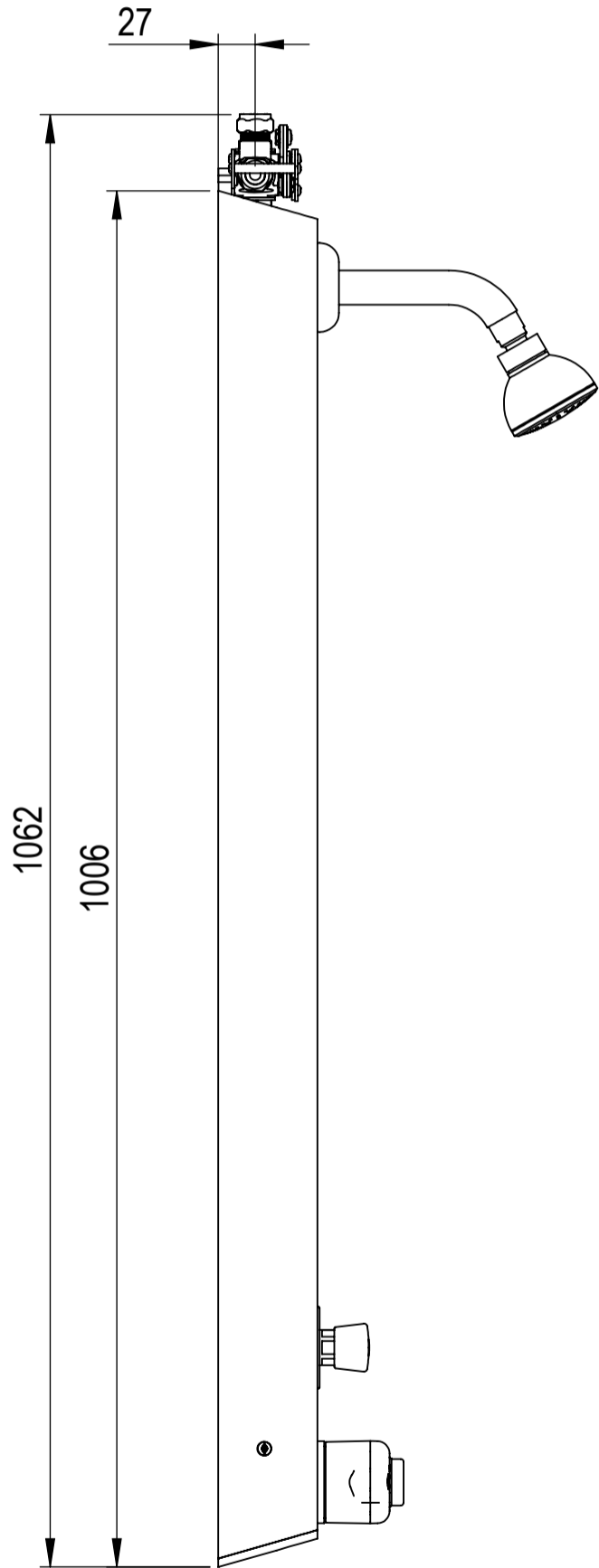
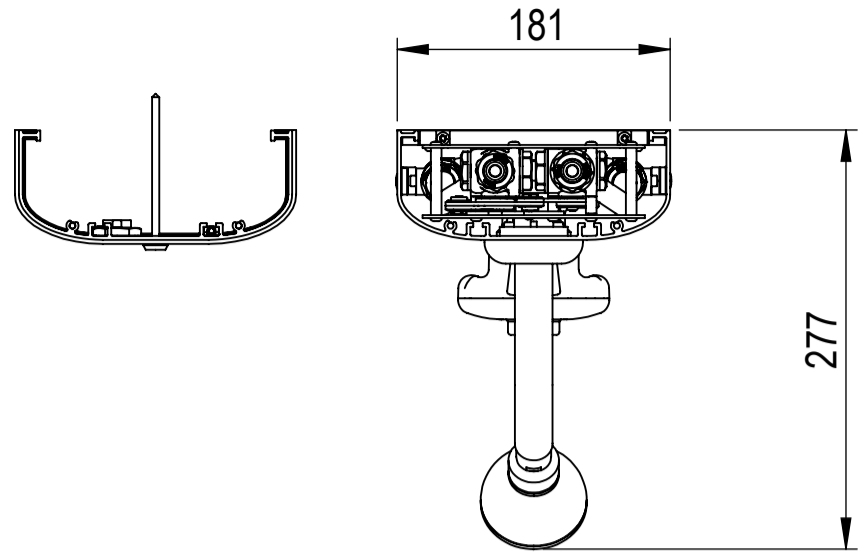

COPYRIGHT 2016, HORNE ENGINEERING LTD. ALL REPRODUCTION PROHIBITED UNLESS AUTHORISED IN WRITING. THIS DRAWING CONTAINS CONFIDENTIAL AND PROPRIETARY INFORMATION OF HORNE ENGINEERING LIMITED AND UNAUTHORISED DISCLOSURE IS STRICTLY PROHIBITED.

DRN BY	MJ (07/01/2016)	MODEL REV.	A-01
CHK'D BY		DRG REV.	B-01

HORNE ENGINEERING LTD. JOHNSTONE RENFREWSHIRE PA5 8BD			CONFIG OF: 6250
SHEET 1 OF 1	DO NOT SCALE	A3	
DRG No. 11366			

PRODUCT: T206T41L