

ALL DIMENSIONS ARE APPROXIMATE

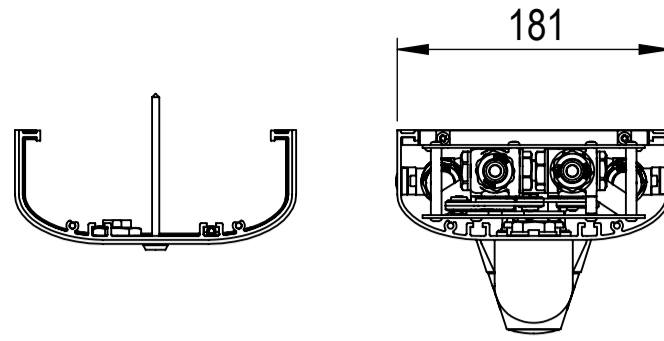

TOTAL HEIGHT OF PANEL + PIPECOVER  
 = 1006 + 2 + 930 + 50 - (OVERLAP)

- OVERLAP IS VARIABLE BETWEEN 20-40MM
- 930 LENGTH CAN BE CUT TO SUIT

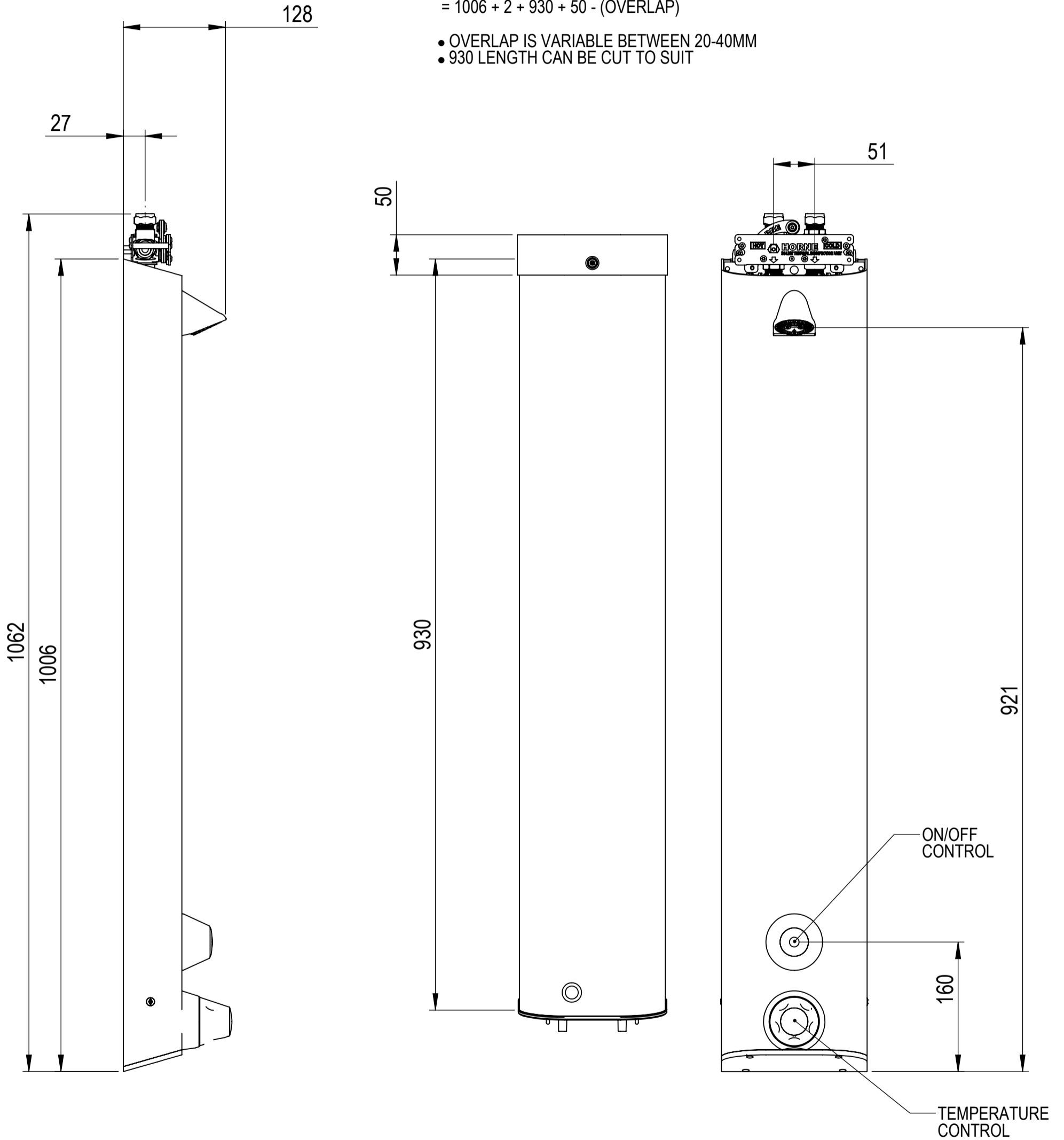

COPYRIGHT 2016, HORNE ENGINEERING LTD. ALL REPRODUCTION PROHIBITED UNLESS AUTHORISED IN WRITING.  
 THIS DRAWING CONTAINS CONFIDENTIAL AND PROPRIETARY INFORMATION OF HORNE ENGINEERING LIMITED AND UNAUTHORISED DISCLOSURE IS STRICTLY PROHIBITED.

DRN BY MJ (07/01/2016)	MODEL REV. A-01
CHK'D BY	DRG REV. B-01

HORNE ENGINEERING LTD. JOHNSTONE RENFREWSHIRE PA5 8BD			CONFIG OF: 6250
SHEET 1 OF 1	DO NOT SCALE	A3	
DRG No. 11361			

PRODUCT: T113T9LR